

# Spinning Dreidel

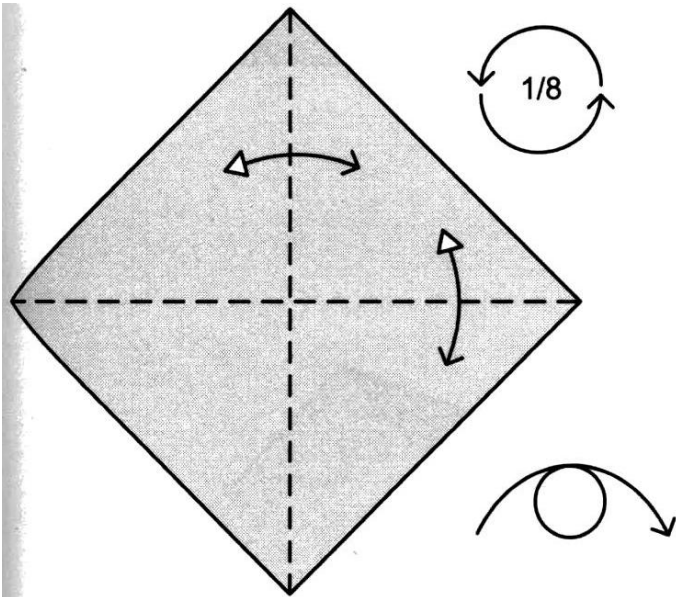

1. Begin with the color side up. Valley-fold the left corner to the right and unfold. Valley-fold the top corner to the bottom and unfold. Rotate  $1/8$  and turn over.

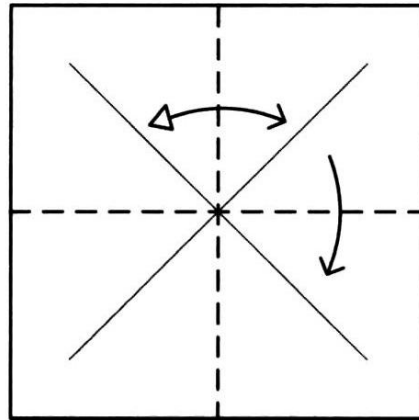

2. Valley-fold left side to right and unfold. Valley-fold the top to the bottom.

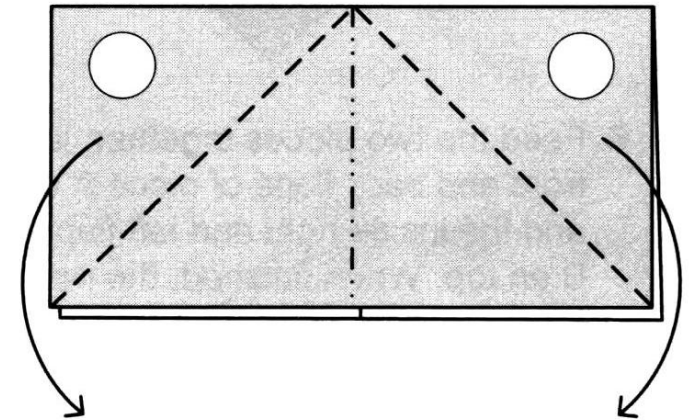

3. Grasp the model at the circles and swing the lower corners down and together. As you do this, flaps will emerge from the center of the model in front and back.

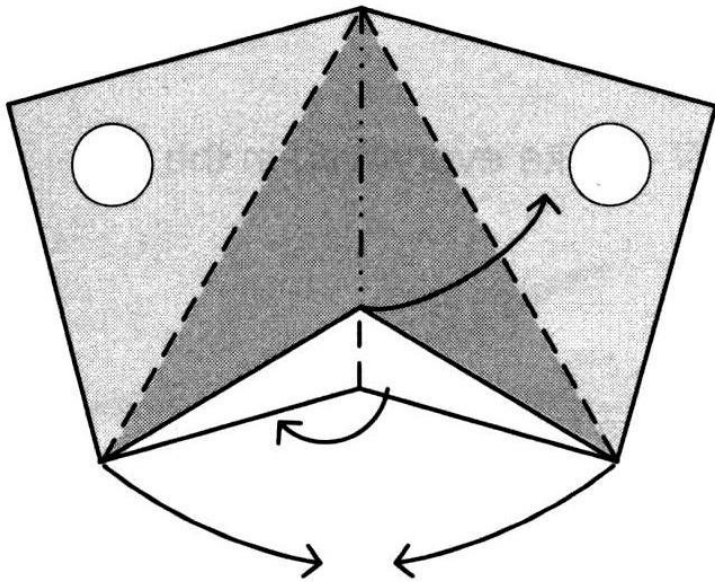

Step 3 in progress

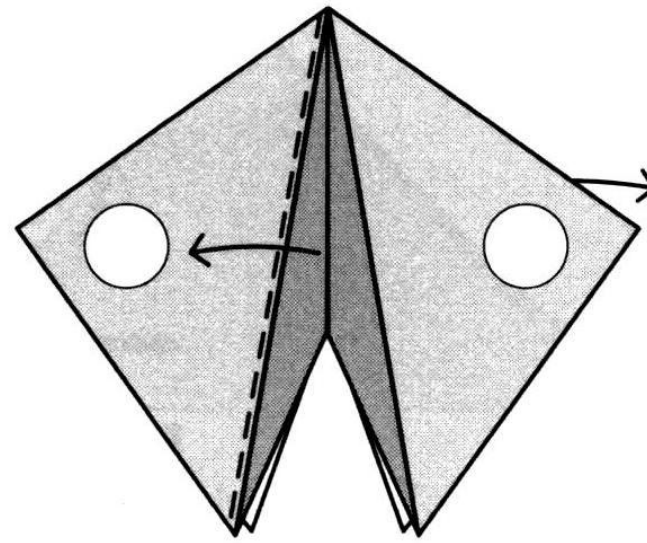

4. Swivel the front flap to the left, and the rear flap to the right. Then lay the model flat.

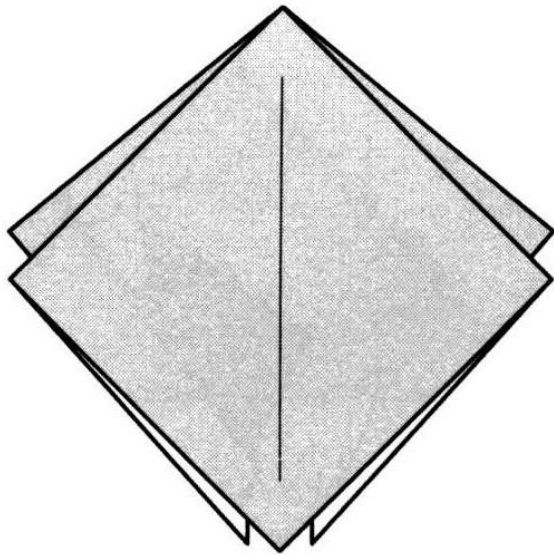

5. Half the dreidel is complete. Make another piece using a different color.

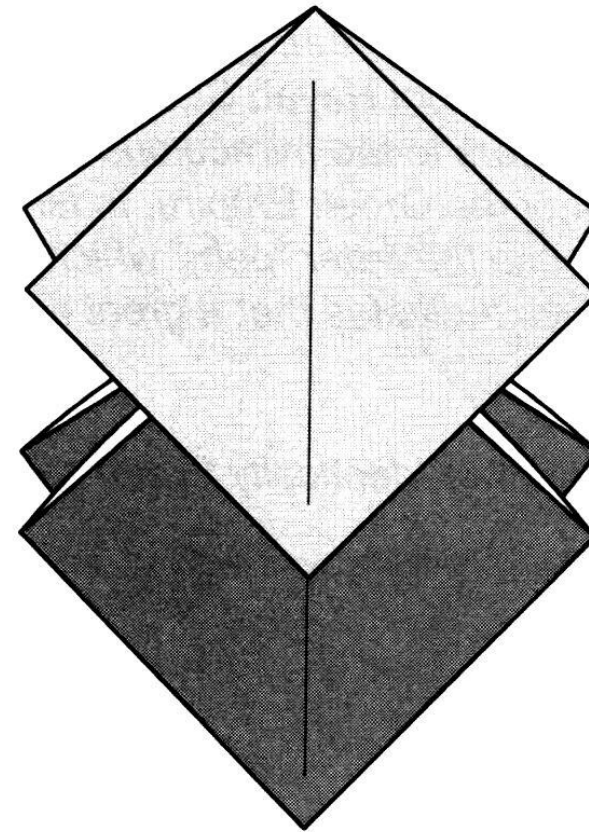
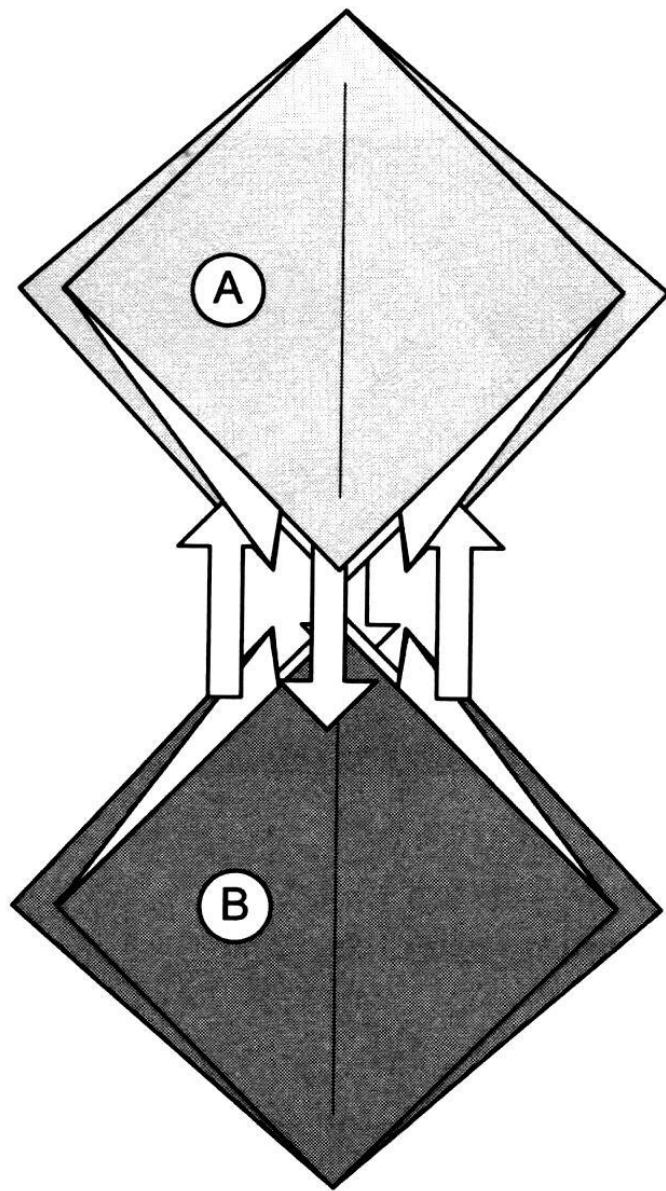

Step 6 in progress

6. Feed the two pieces together, laying the front and back flaps of piece A on top, and the inside right and left flaps of piece B on top. When finished, the model will have sides of alternating colors.

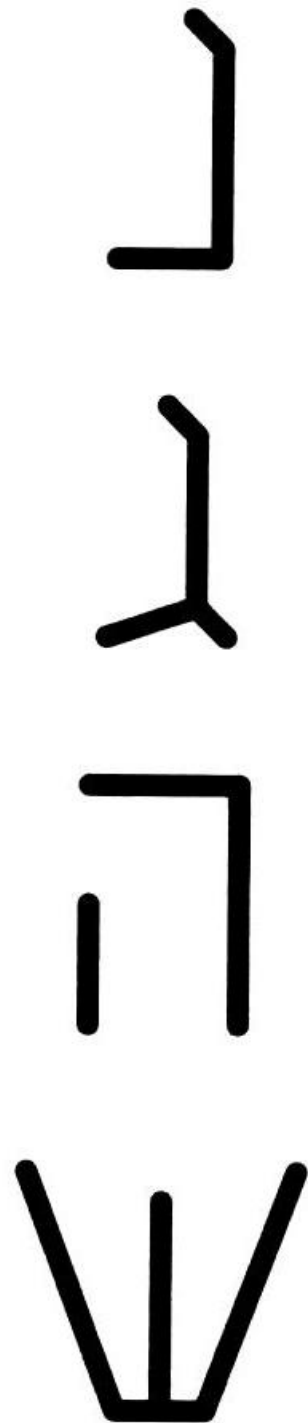
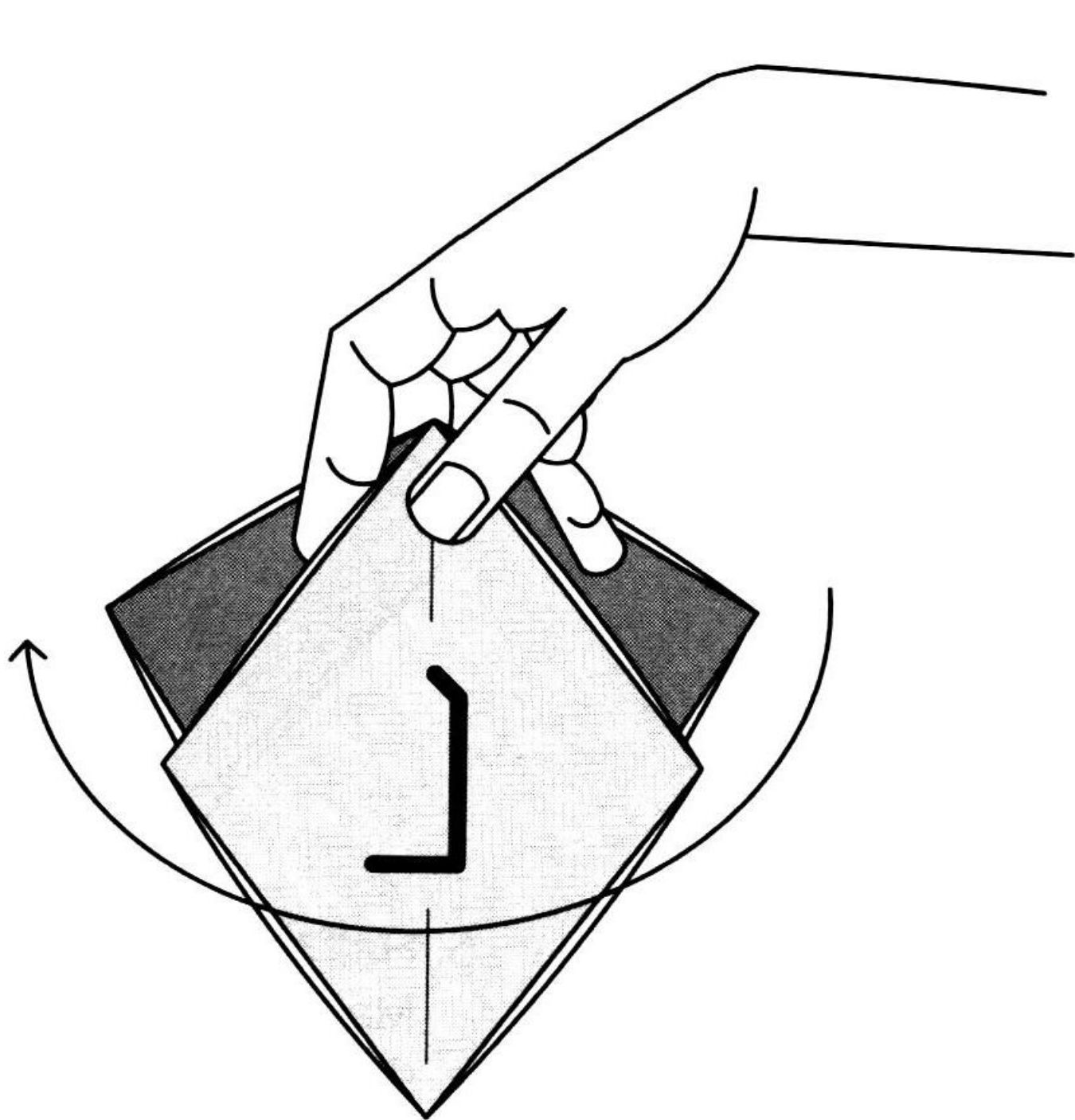

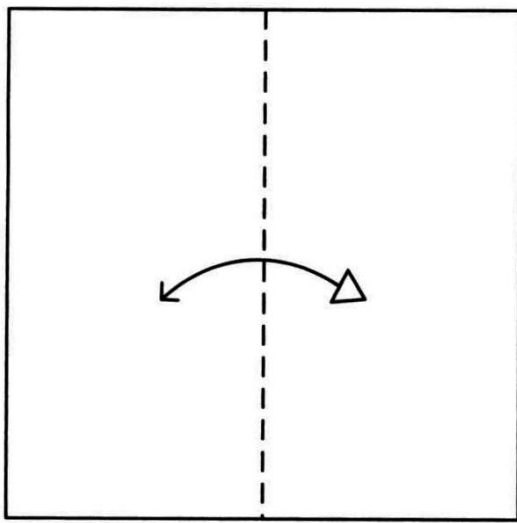

1. Begin with the white side up. Valley-fold and unfold the model side to side.

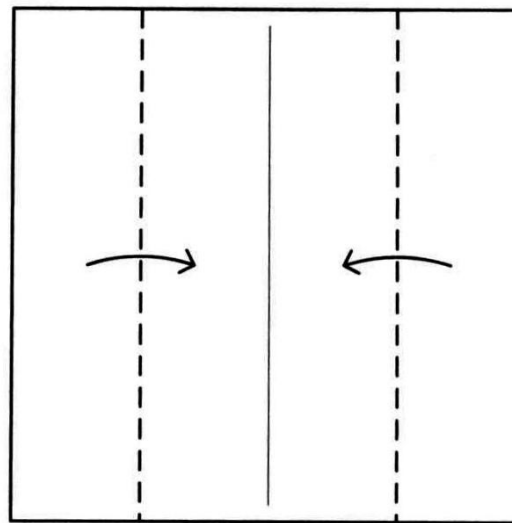

2. Valley-fold both sides to the center.

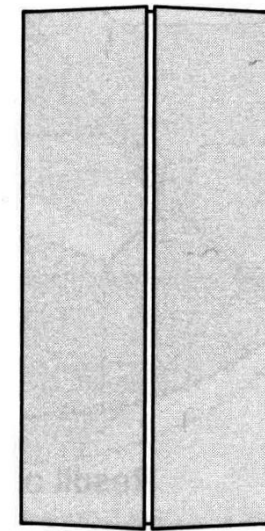

3. Turn the model over.

# Chanukiya

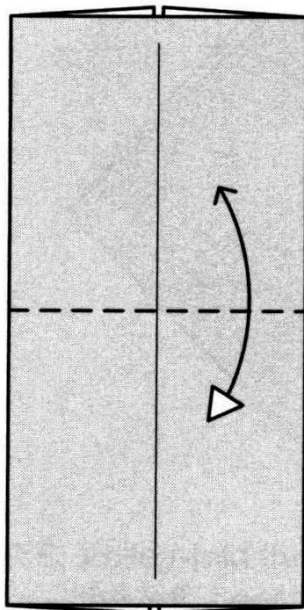

4. Valley-fold and unfold the bottom edge to the top.

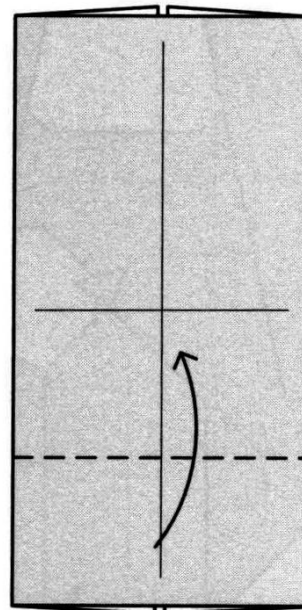

5. Valley-fold the bottom edge to the crease you made in the previous step.

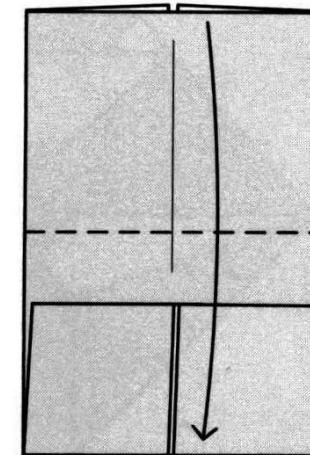

6. Valley-fold the top edge to the bottom edge.

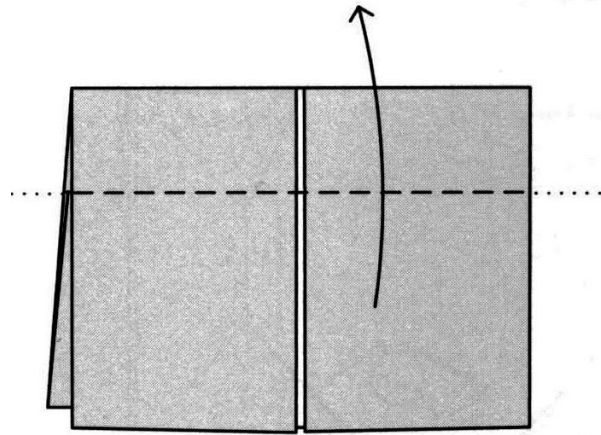

7. Valley-fold the bottom edge up, making a crease that lies along the top edge of the underlying flap (shown with a dotted line).

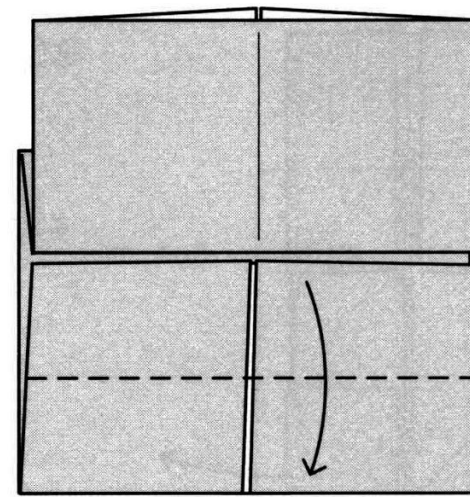

8. Valley-fold the top edge of the lower flap to lie along the bottom.

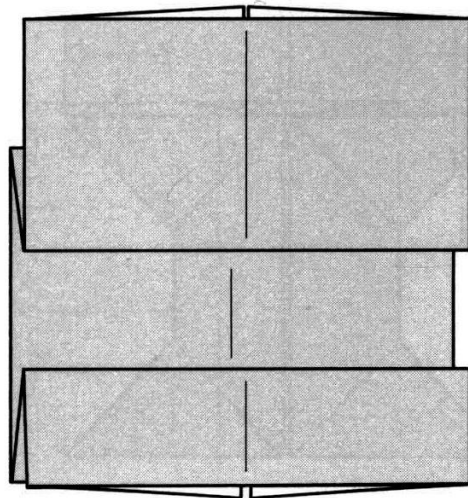

9. Turn the model over.

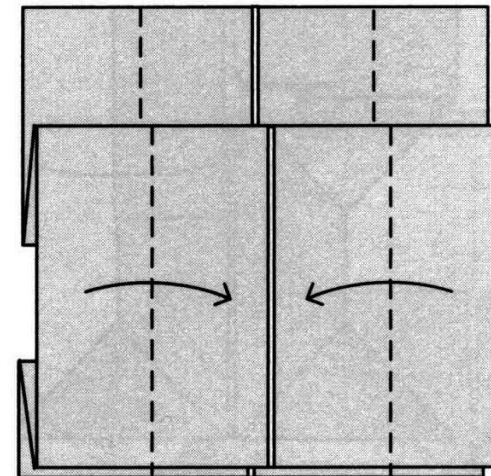

10. Valley-fold the two sides to the center through all thicknesses.

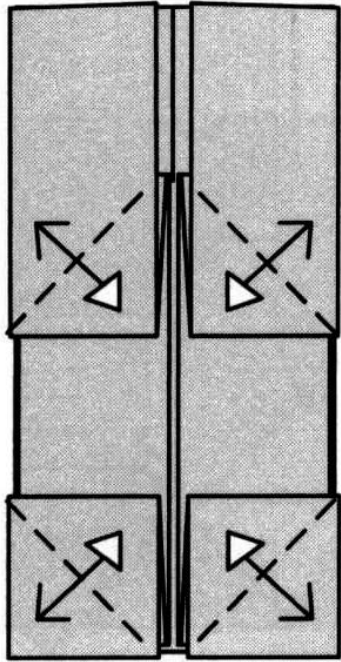

11. Valley-fold the four inside corners outward at  $45^\circ$ . Then unfold.

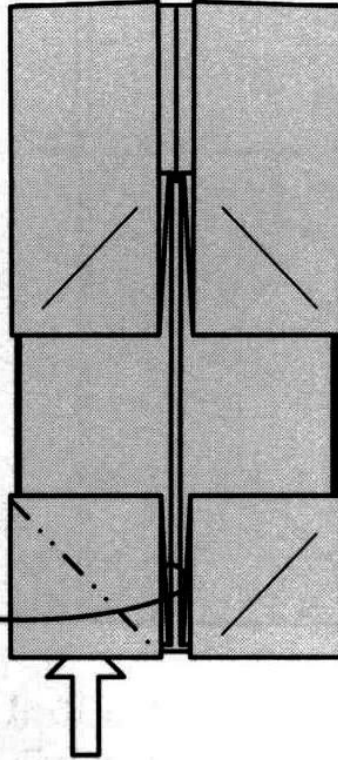

12. Insert your finger under the square flap at the lower left, and open it to the left. When it becomes triangular, squash it flat.

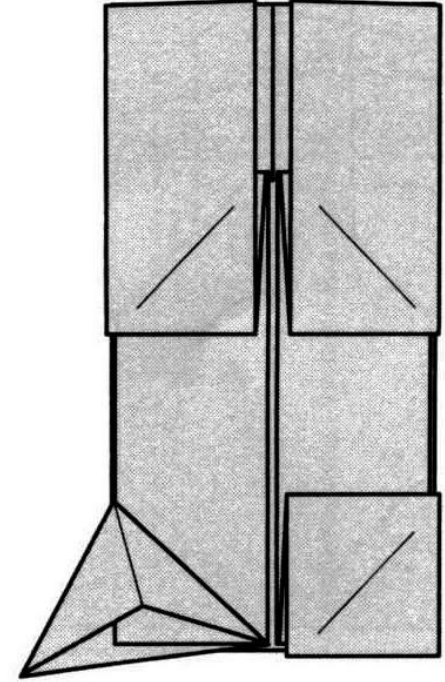

Step 12 in progress

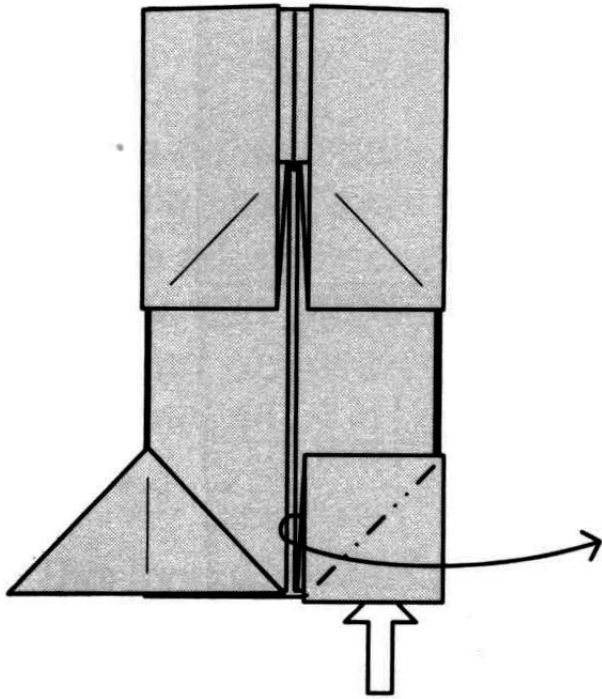

13. Repeat step 12 on the lower right flap.

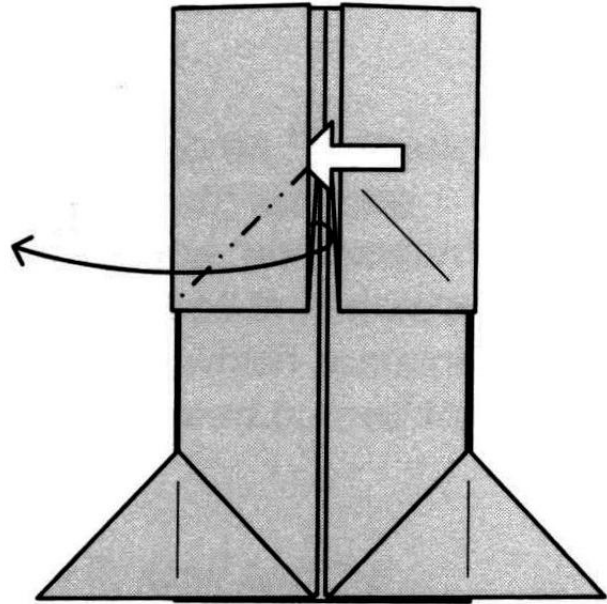

14. Do the same move on the upper left flap.

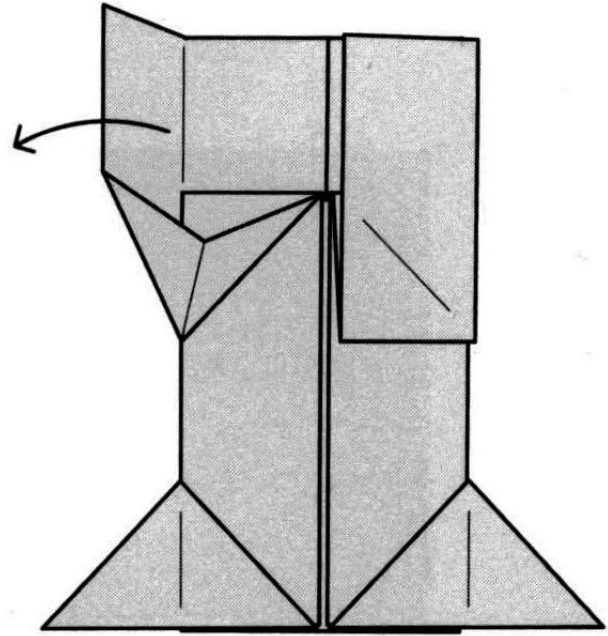

Step 14 in progress

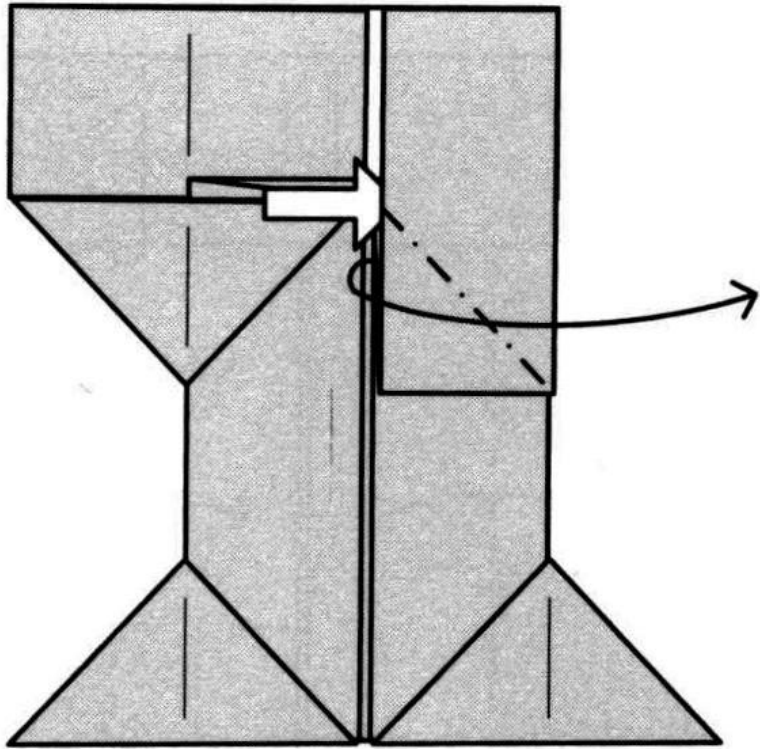

15. Repeat step 14 on the upper right flap.

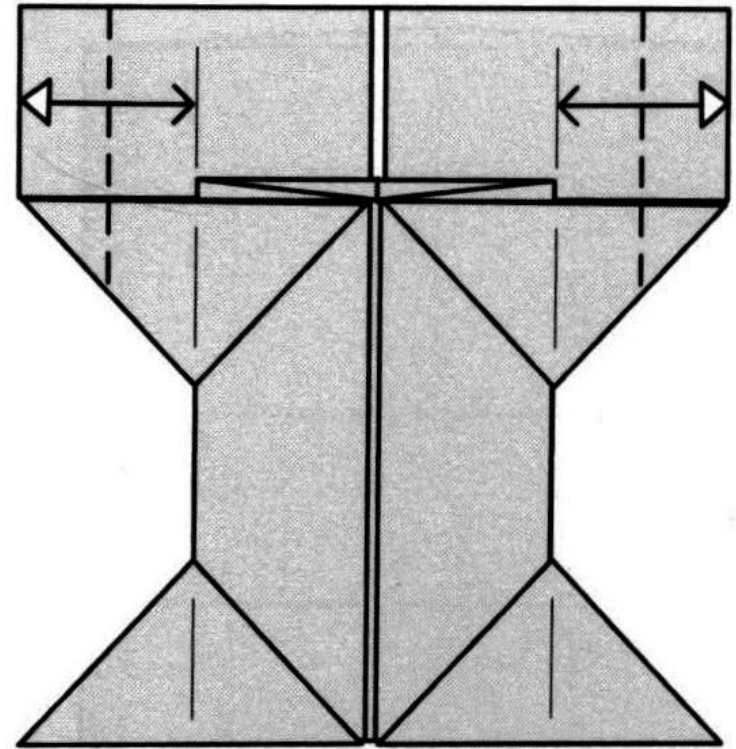

16. Valley-fold and unfold the left and right edges to the creases indicated.

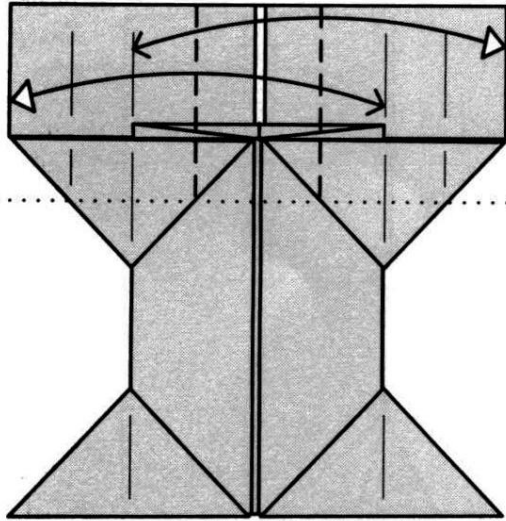

17. Valley-fold and unfold the left and right edges to the same creases as in step 16, but on the opposite side of the model. Only crease down as far as the dotted line.

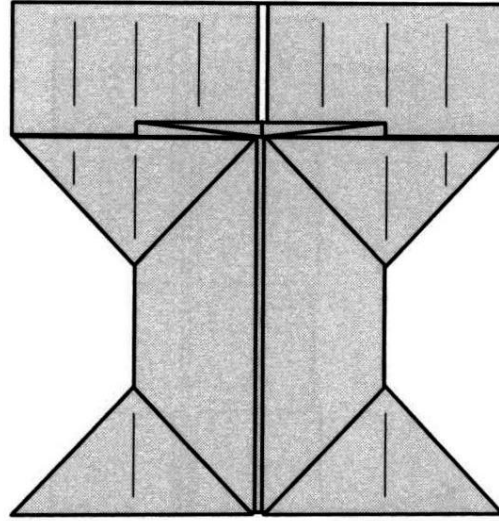

17. The result is that the top of the menorah will be divided into eight sections. Turn the model over.

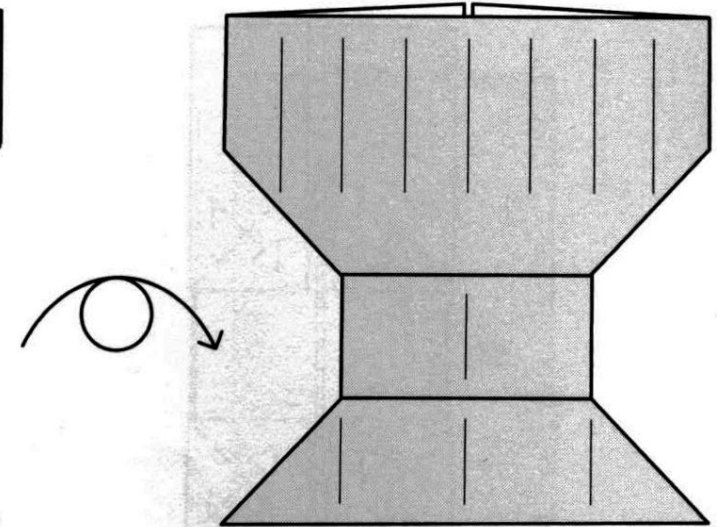

**The Menorah**

## Menorah Candles

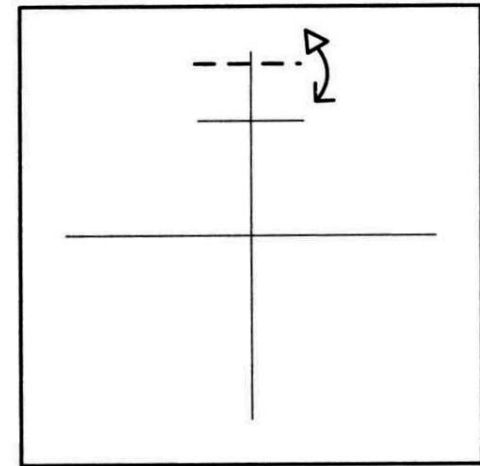
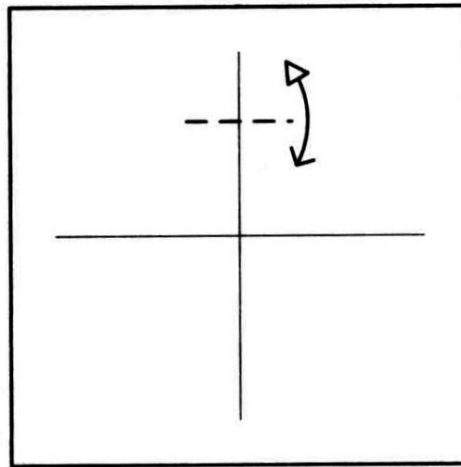
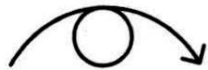
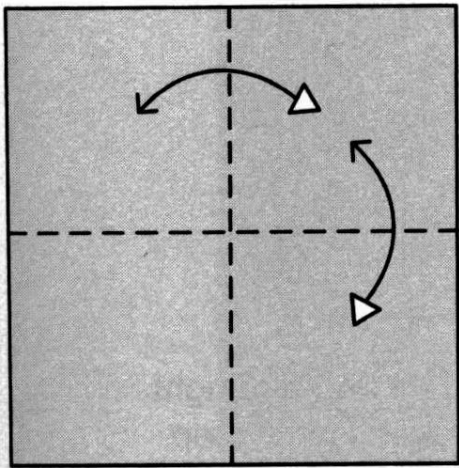

1. Begin with the color side up. Valley-fold and unfold the model side to side in both directions. Then turn the model over.

2. Pinch the half-way point between the top edge and the center.

3. Pinch the half-way point between the edge and the pinch mark you made in step 2.

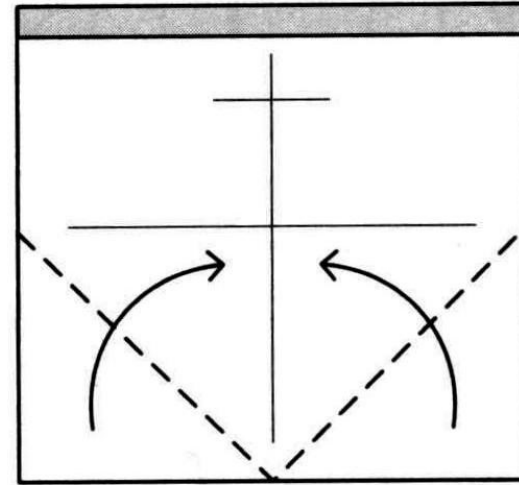
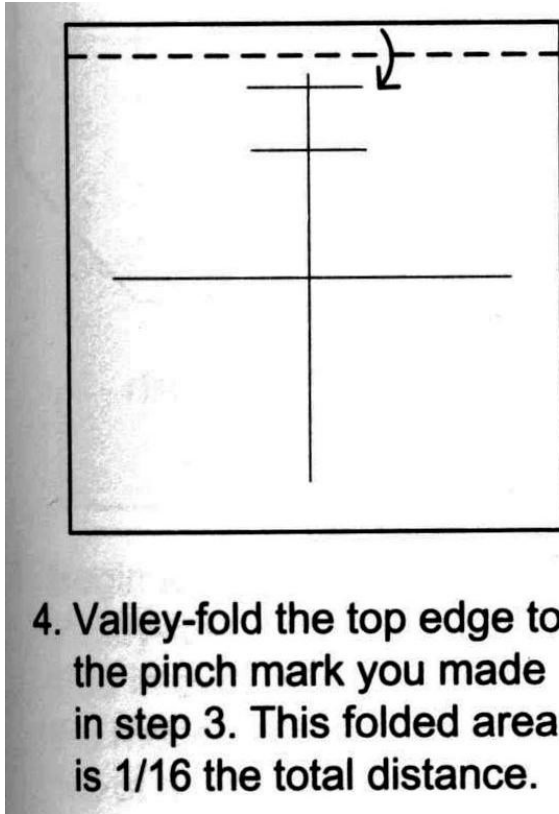

5. Valley-fold both lower corners to the center.

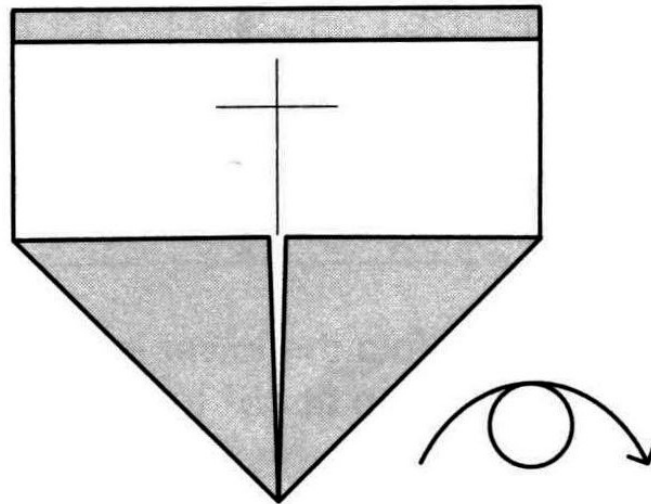

6. Turn the model over.

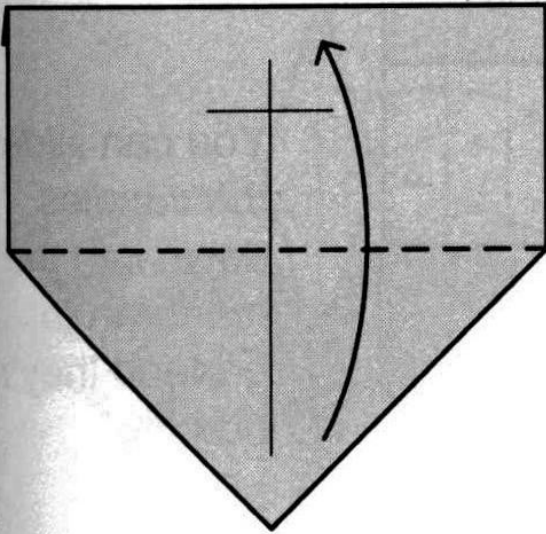

7. Valley-fold the model up at the widest part of the triangular area. The tip will stick out over the top.

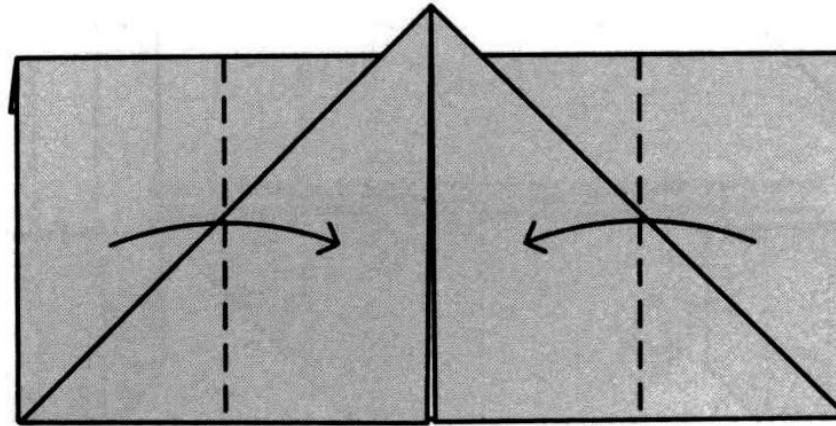

8. Valley-fold both sides to the center.

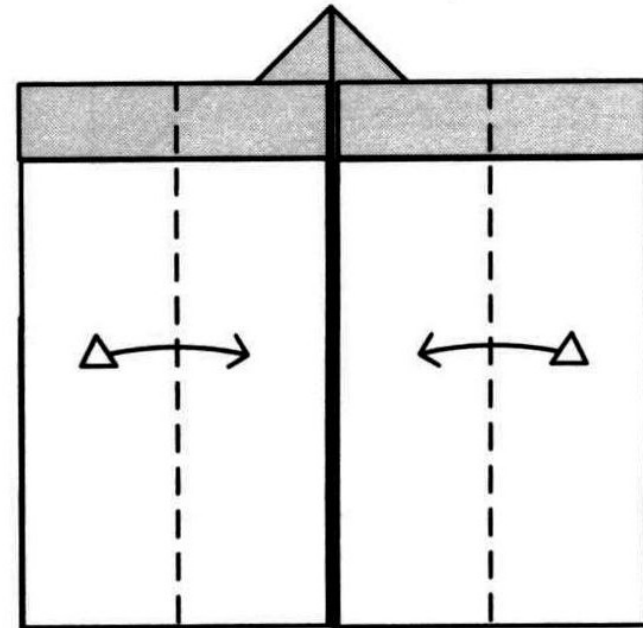

9. Valley-fold and unfold both sides to the center.

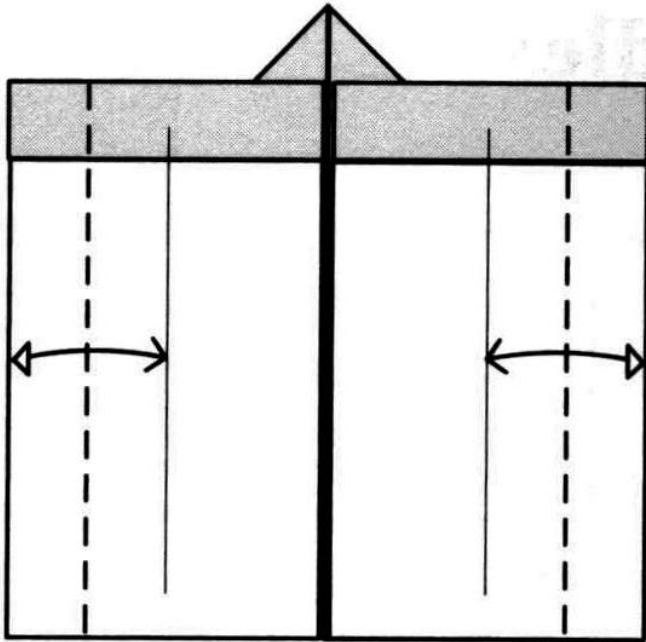

10. Valley-fold and unfold the left and right edges to the creases you made in step 9.

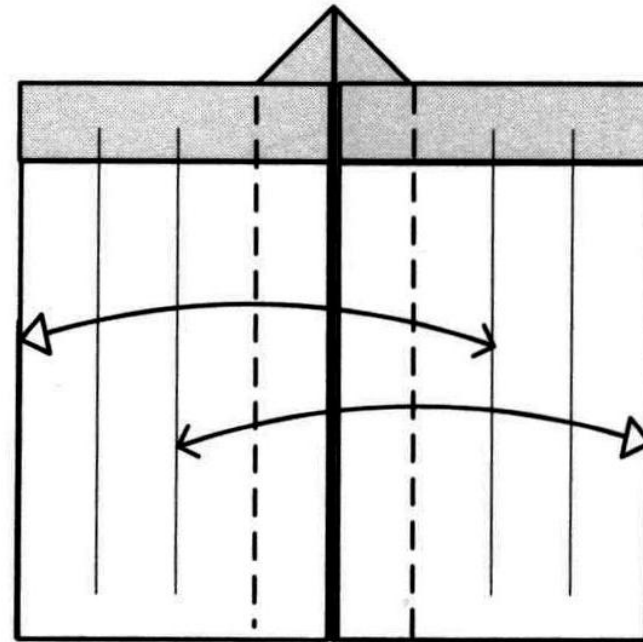

11. Valley-fold and unfold the left and right edges to the same creases as in step 10, but on the opposite side of the model. This makes eight "candles."

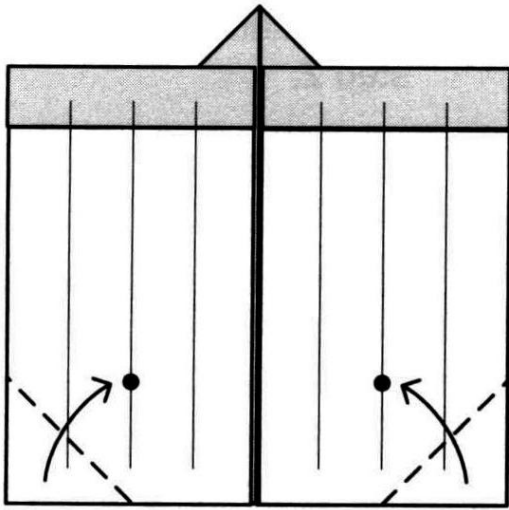

11. Valley-fold the lower left and right corners up at  $45^\circ$  to the dots (the second creases from the right and left).

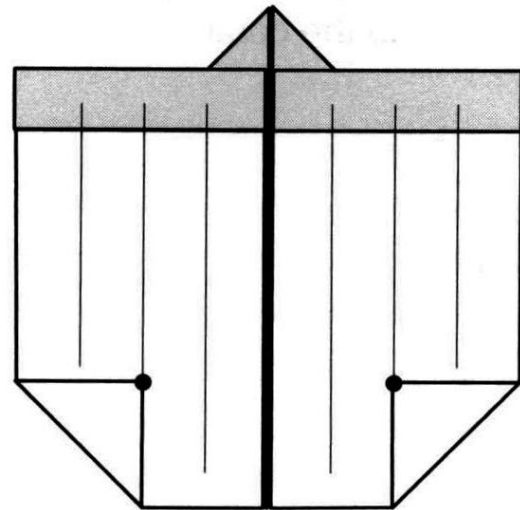

12. Turn the model over.

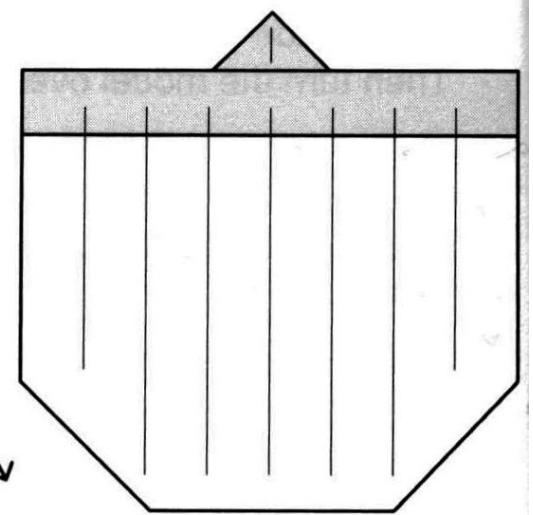

The Menorah  
Candles

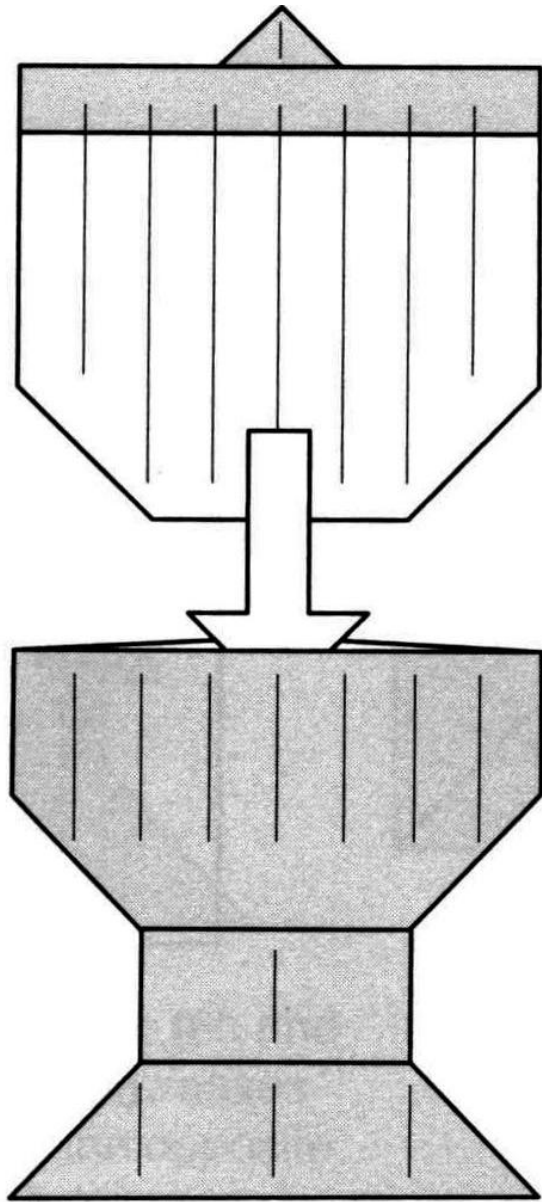

Insert the candles between the front and back flaps of the menorah.

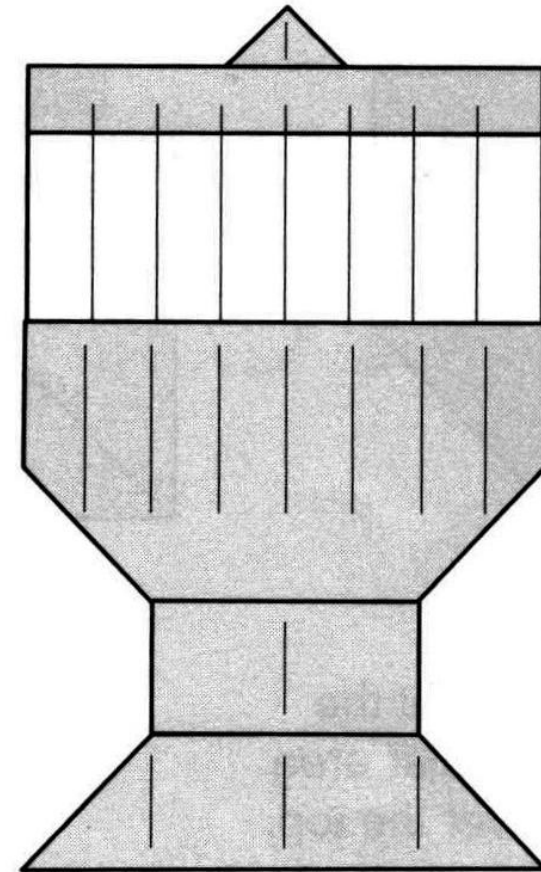

The Menorah with Candles

# Star of David

(from <http://www.origami-resource-center.com/origami-six-pointed-star.html>)

1



2

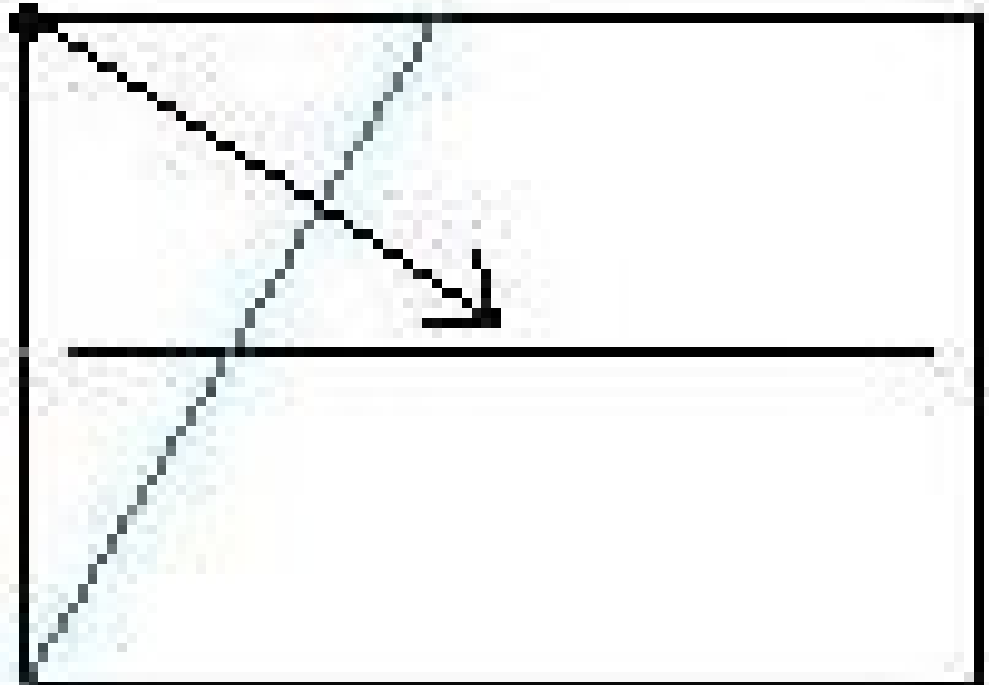

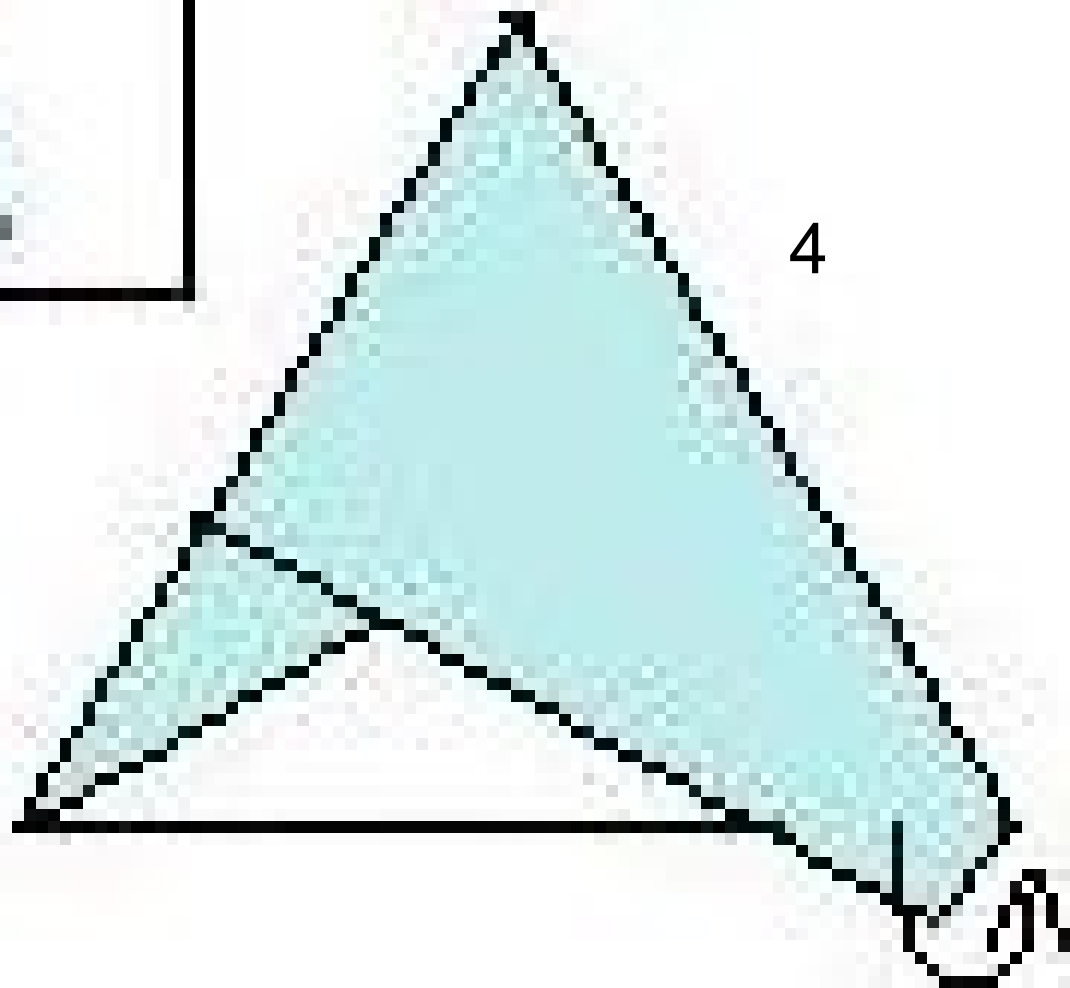
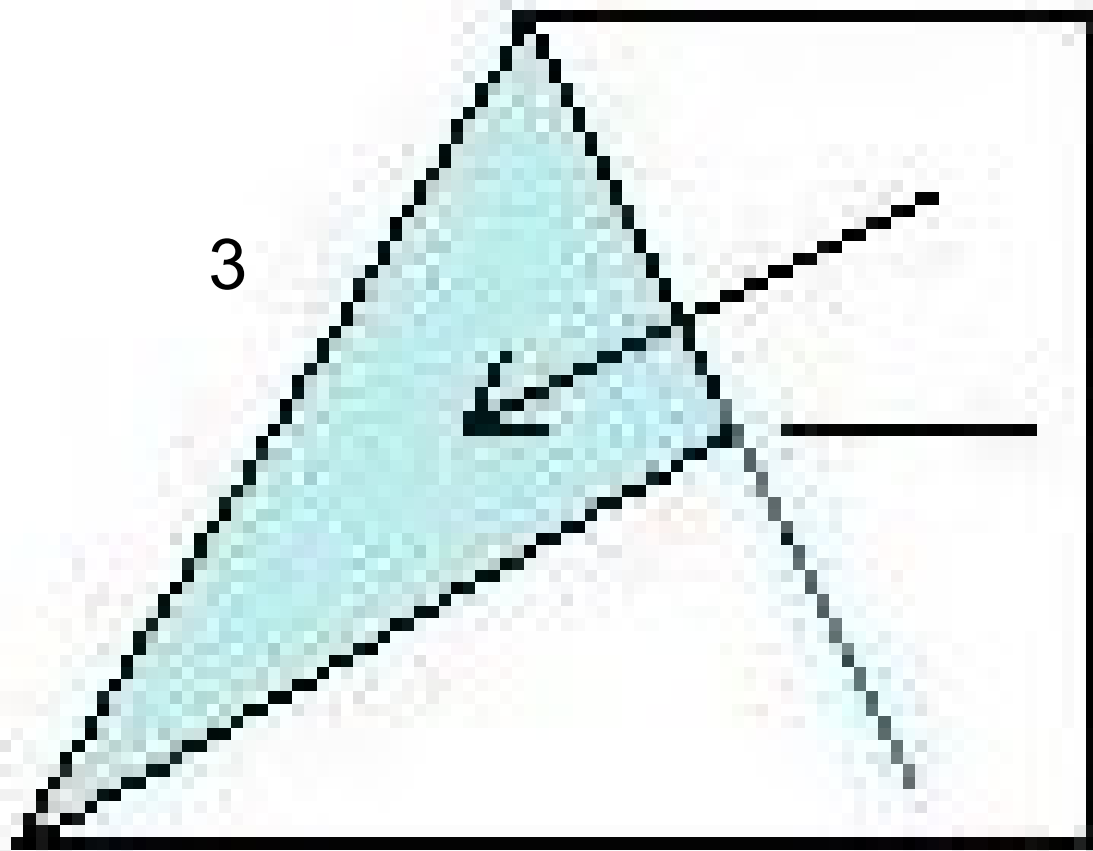

5

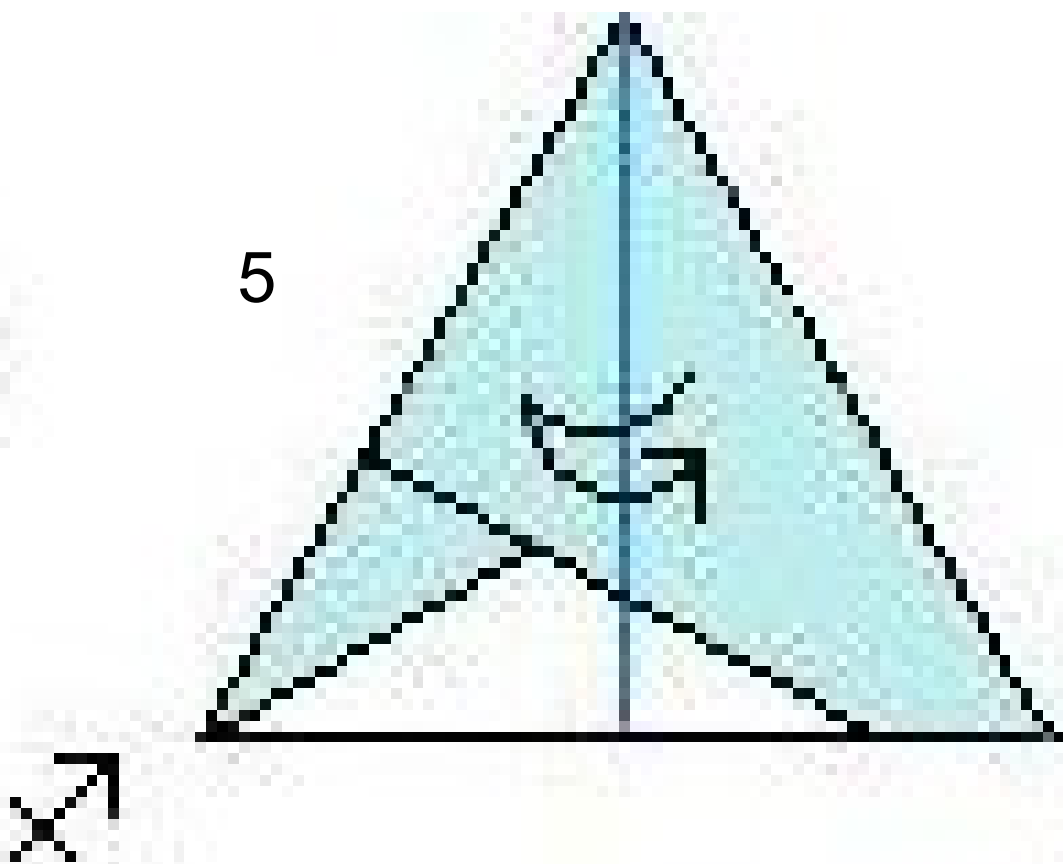

6

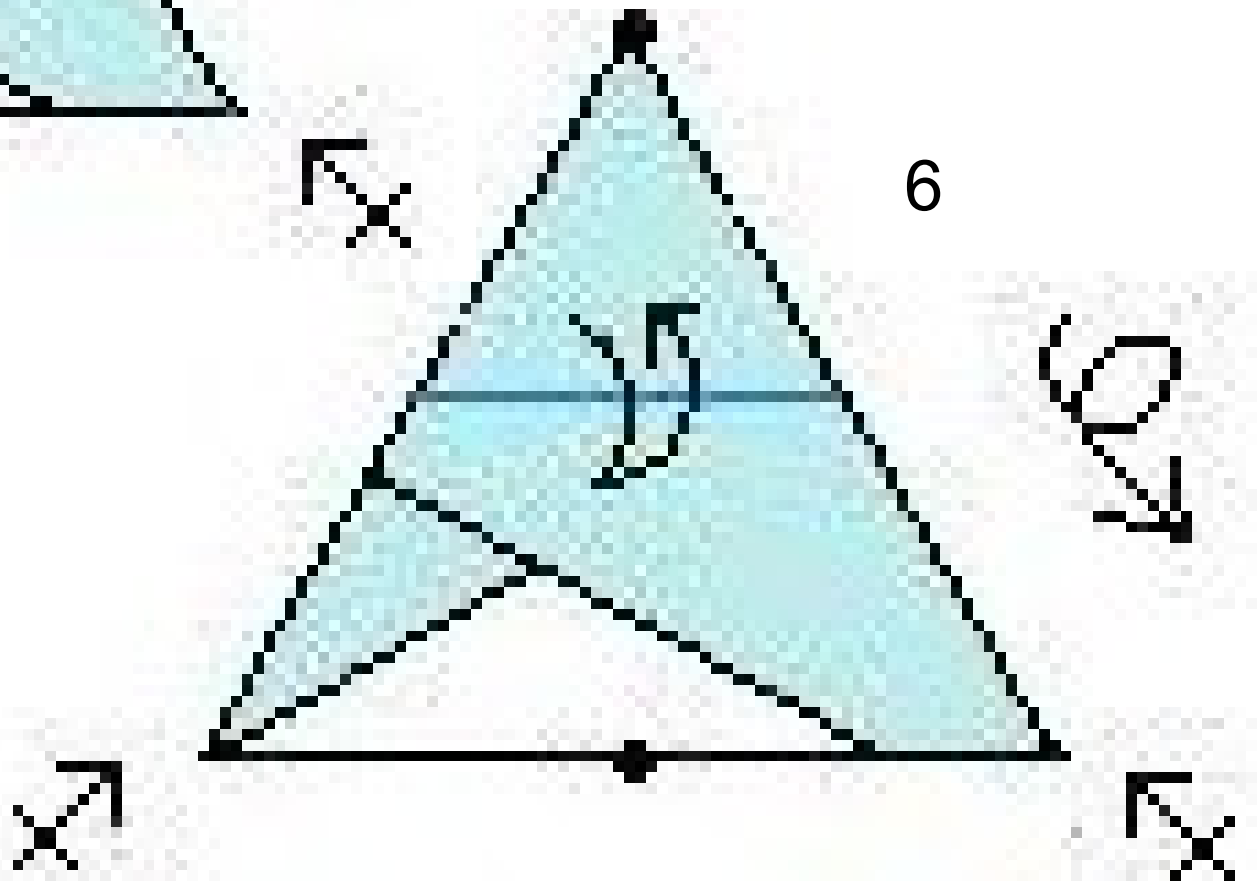

7

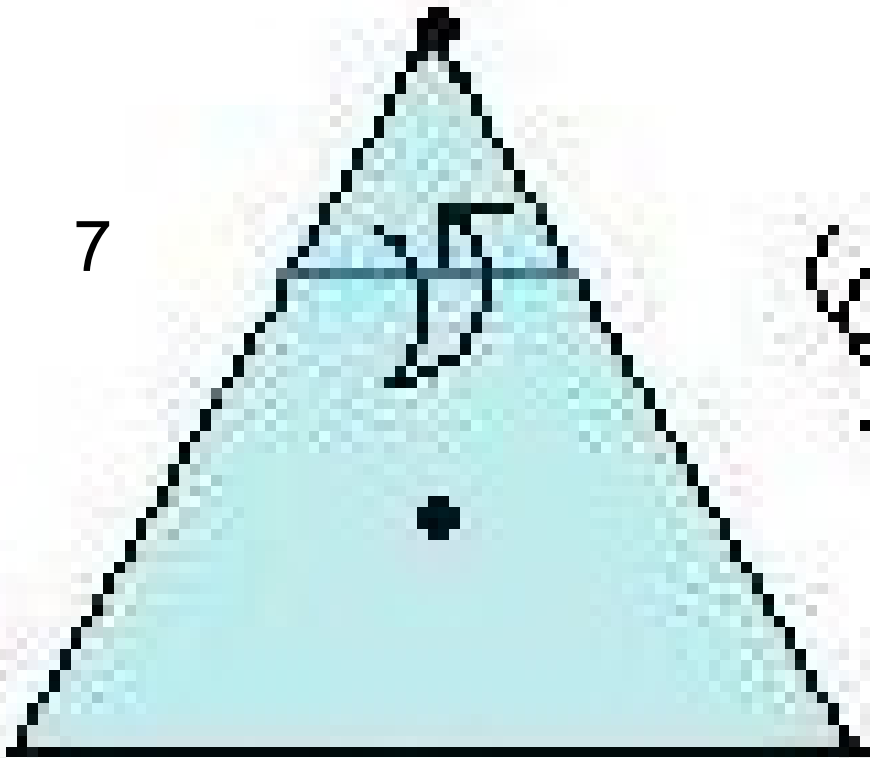

8

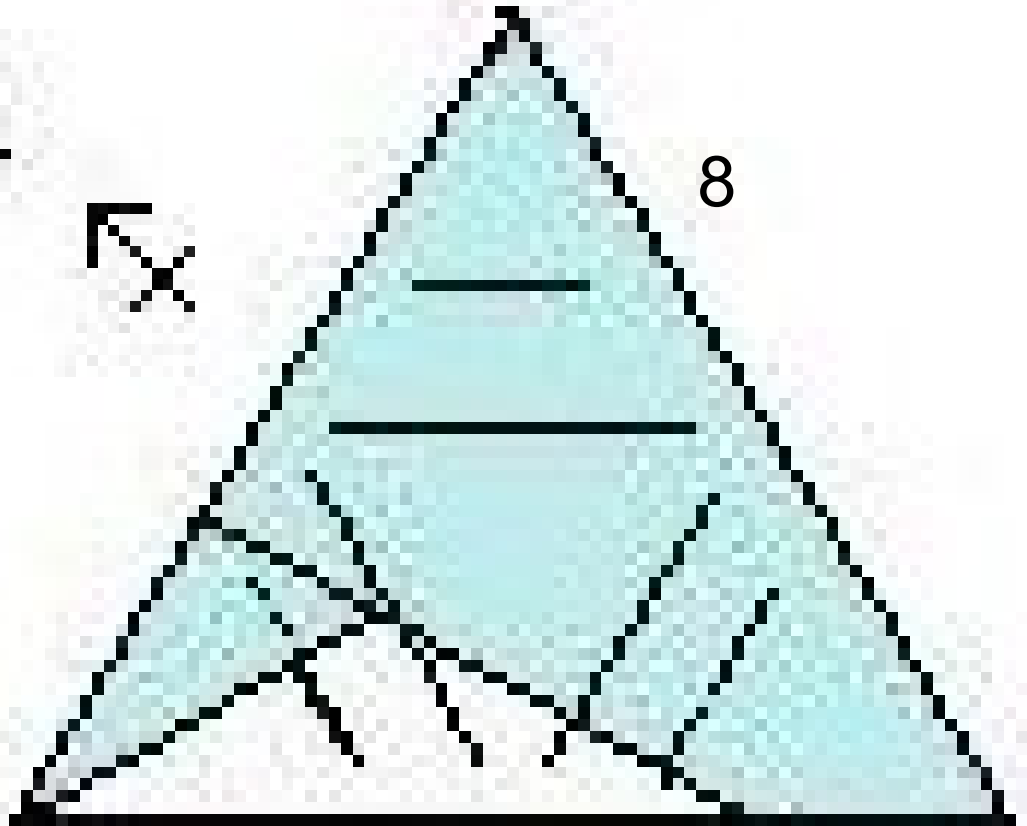

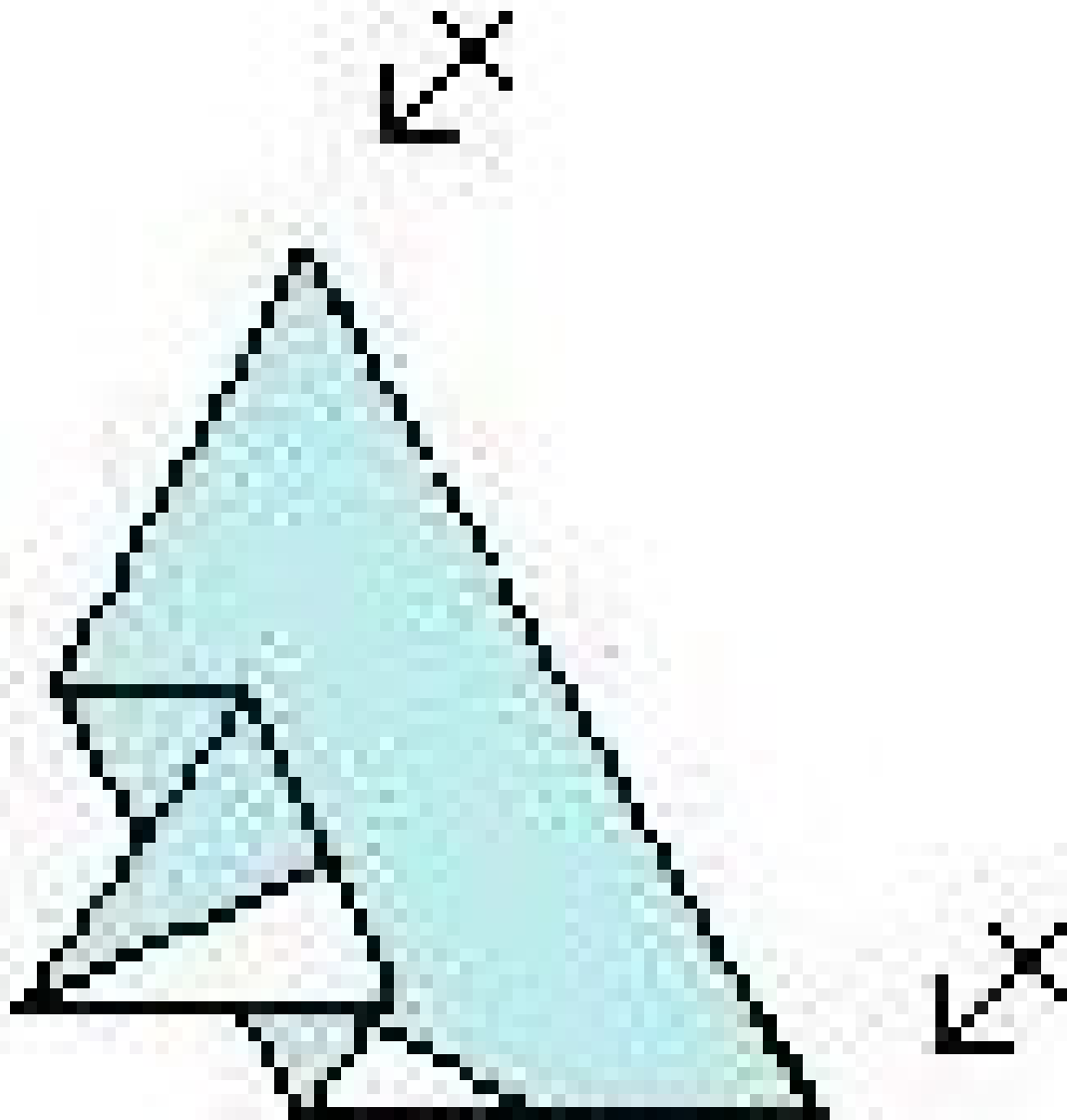

9

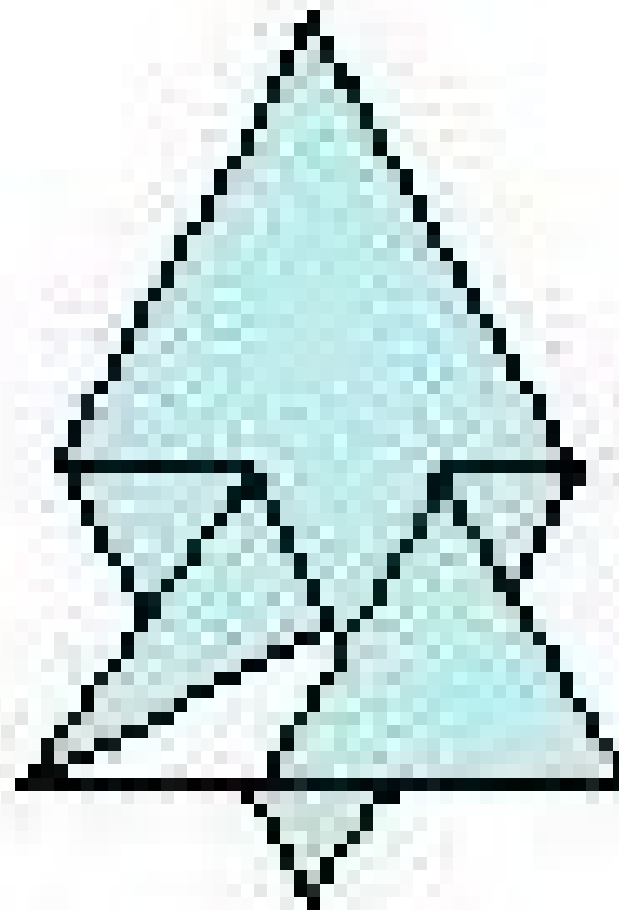

10

11

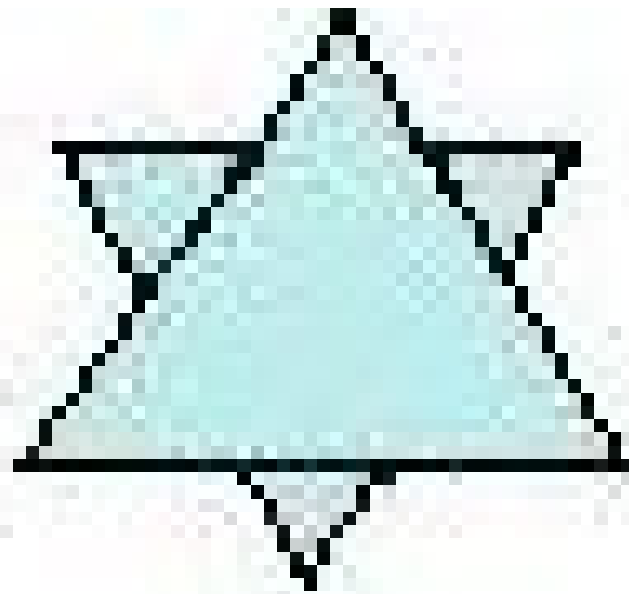
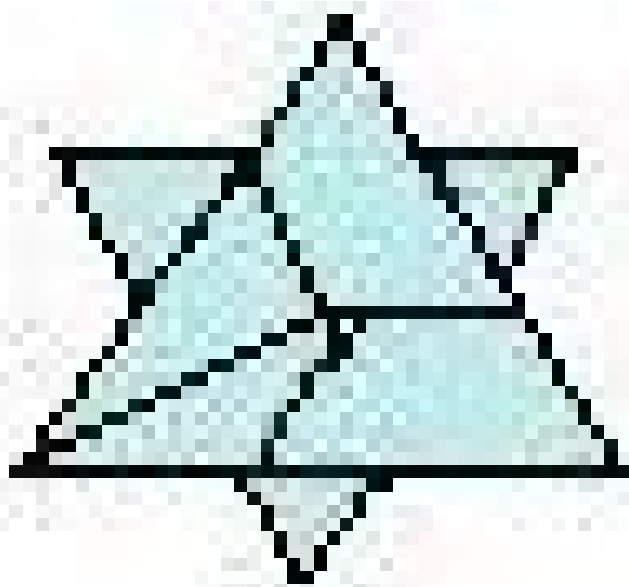

# Dreidel Decoration

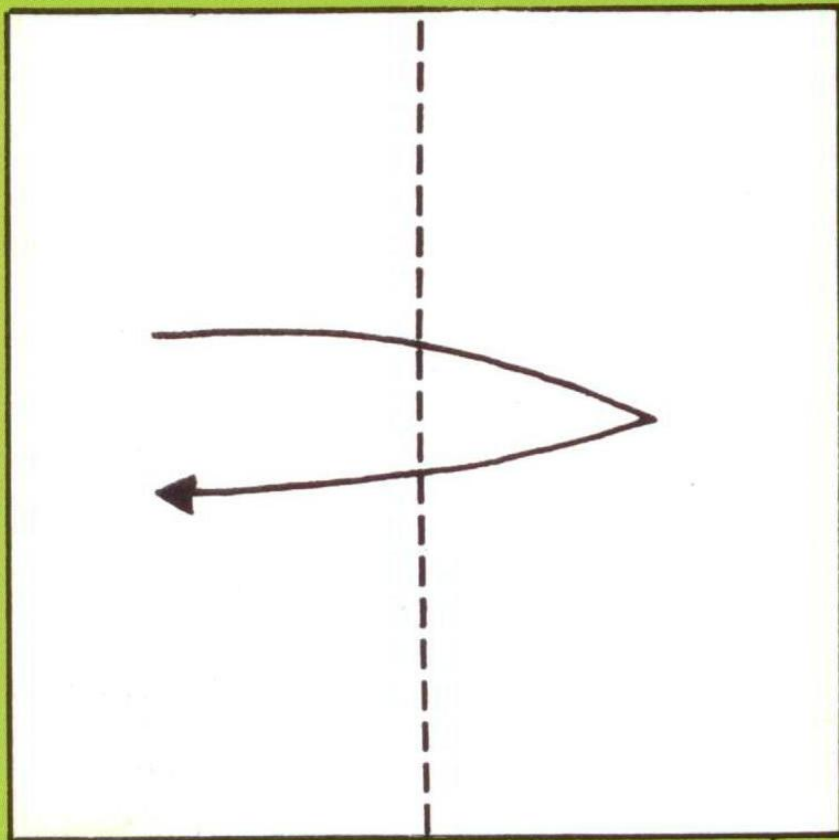

1.

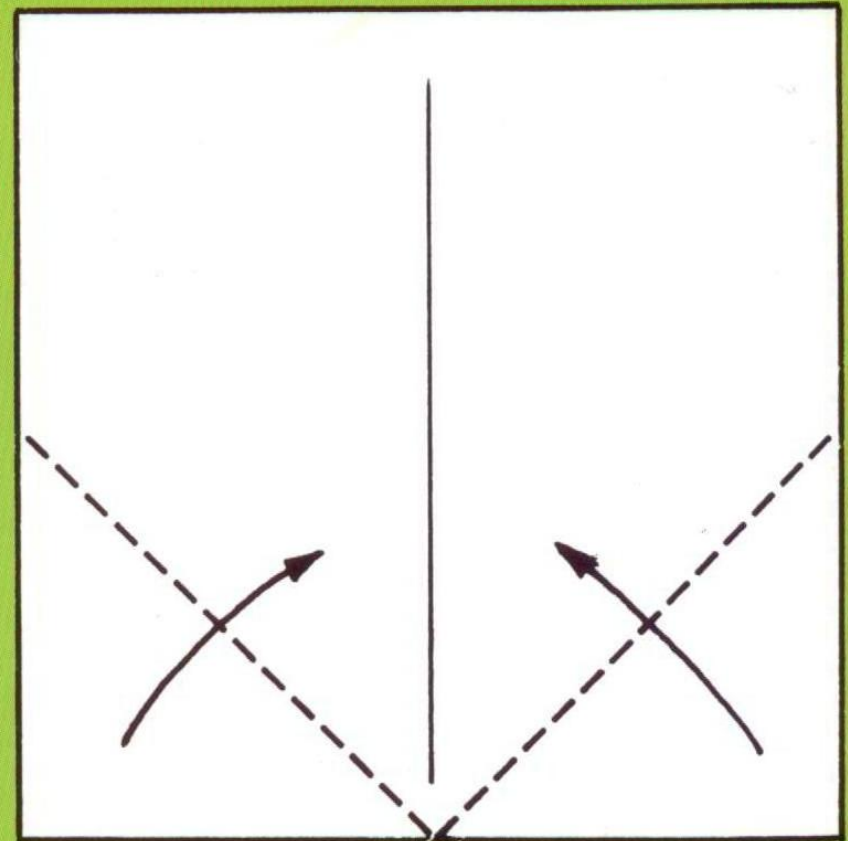

2.

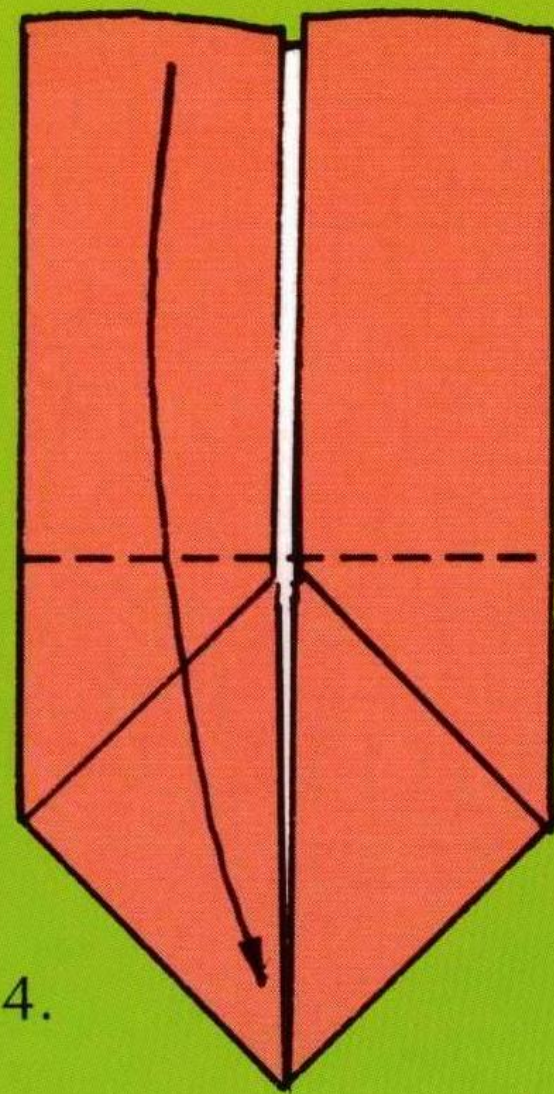
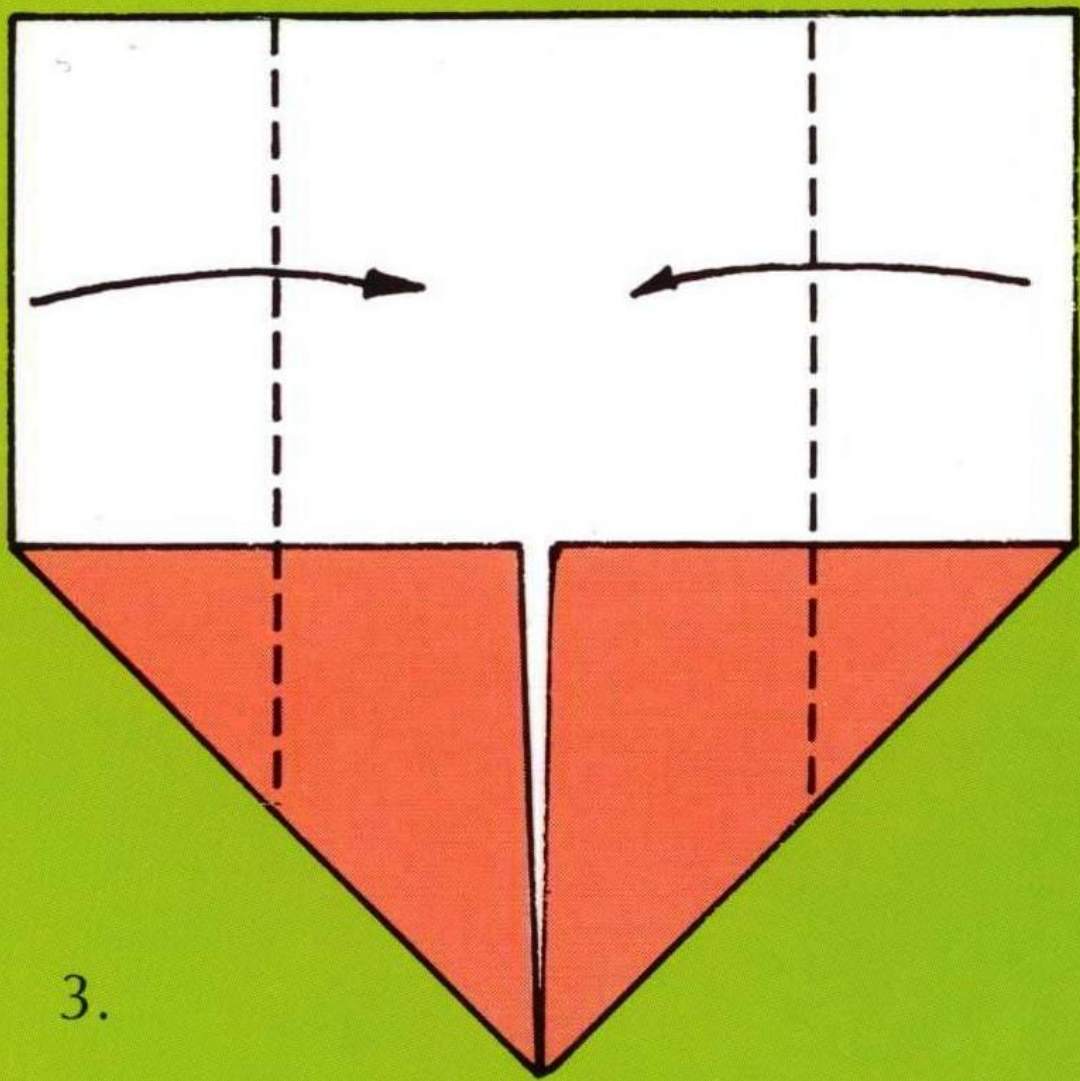

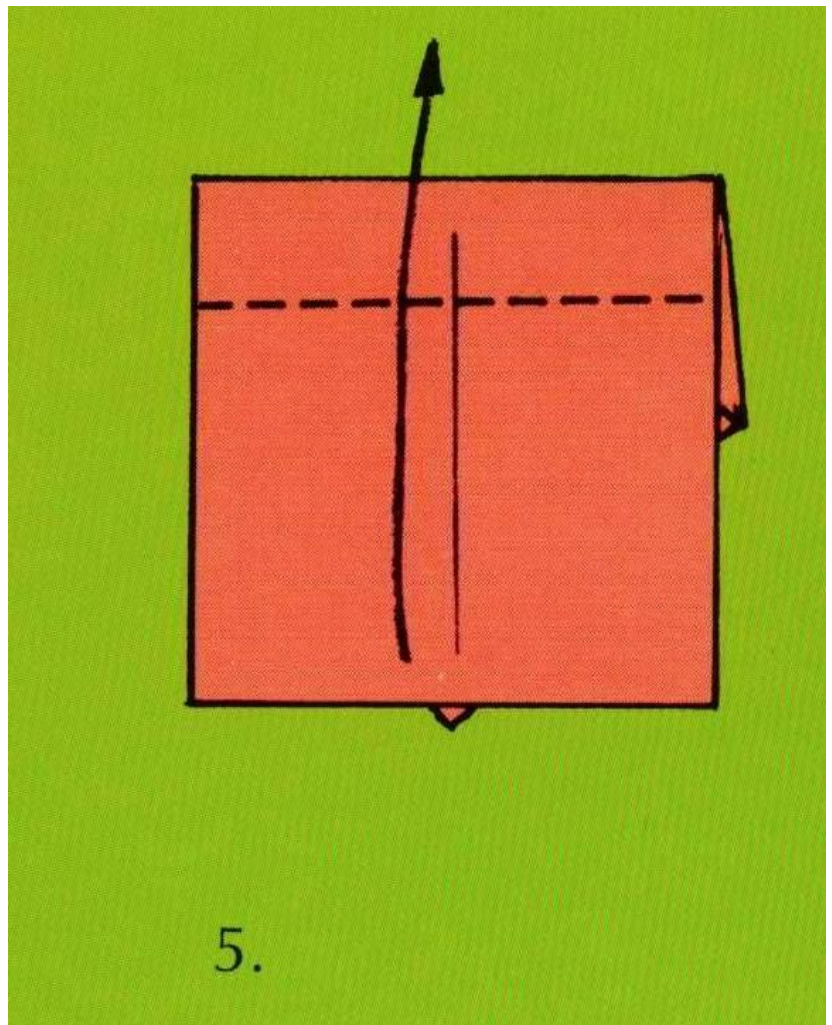
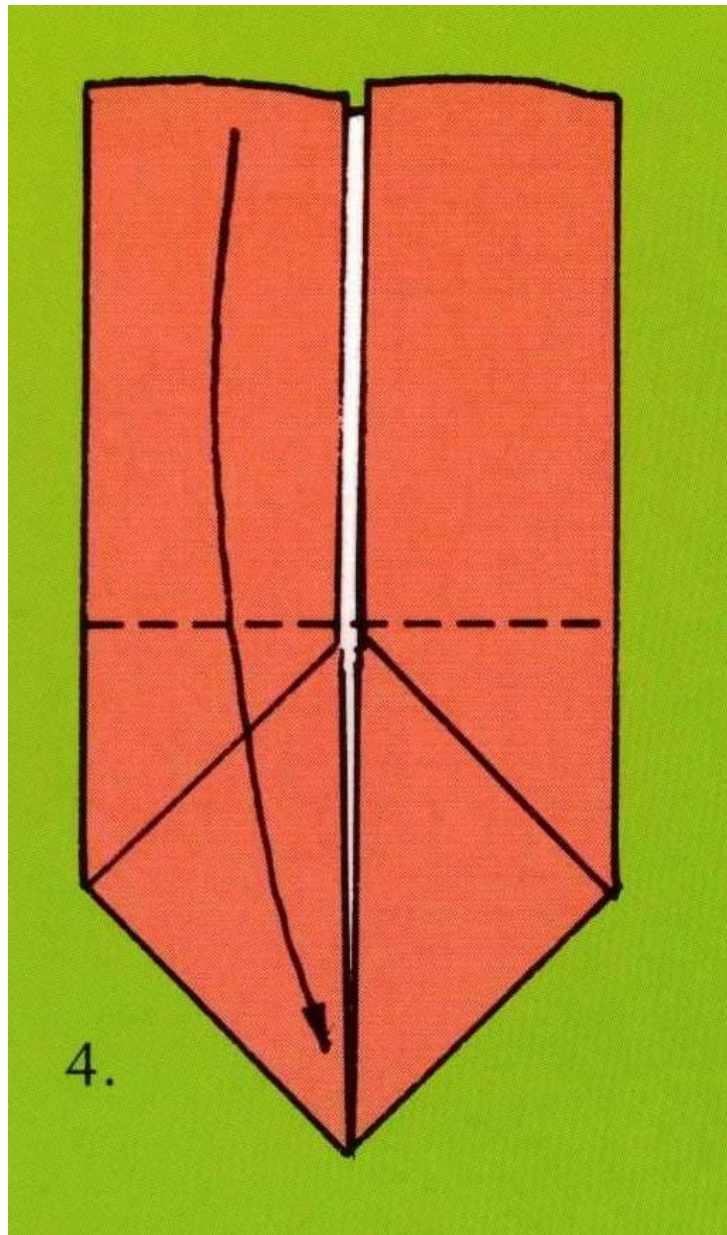

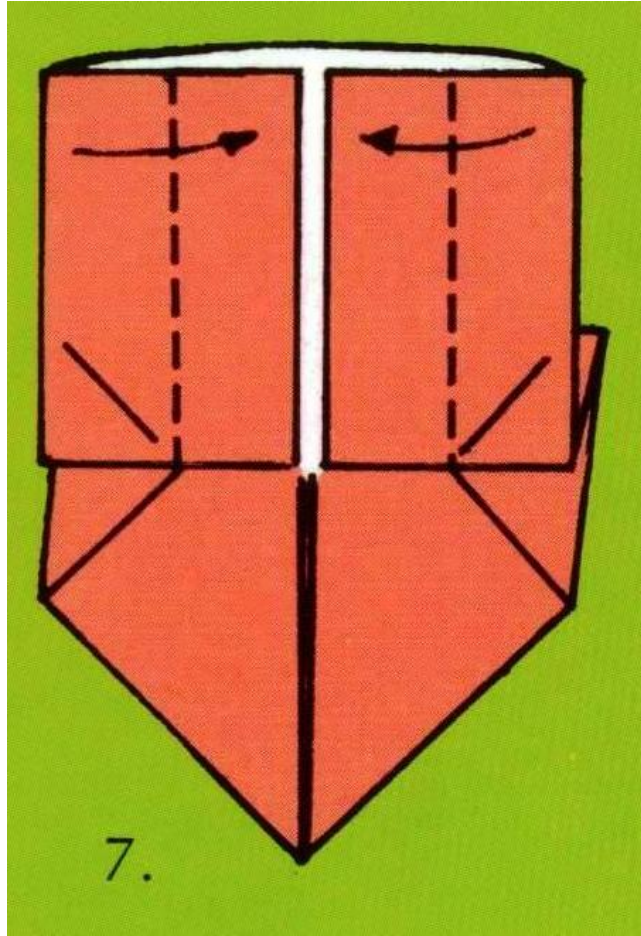
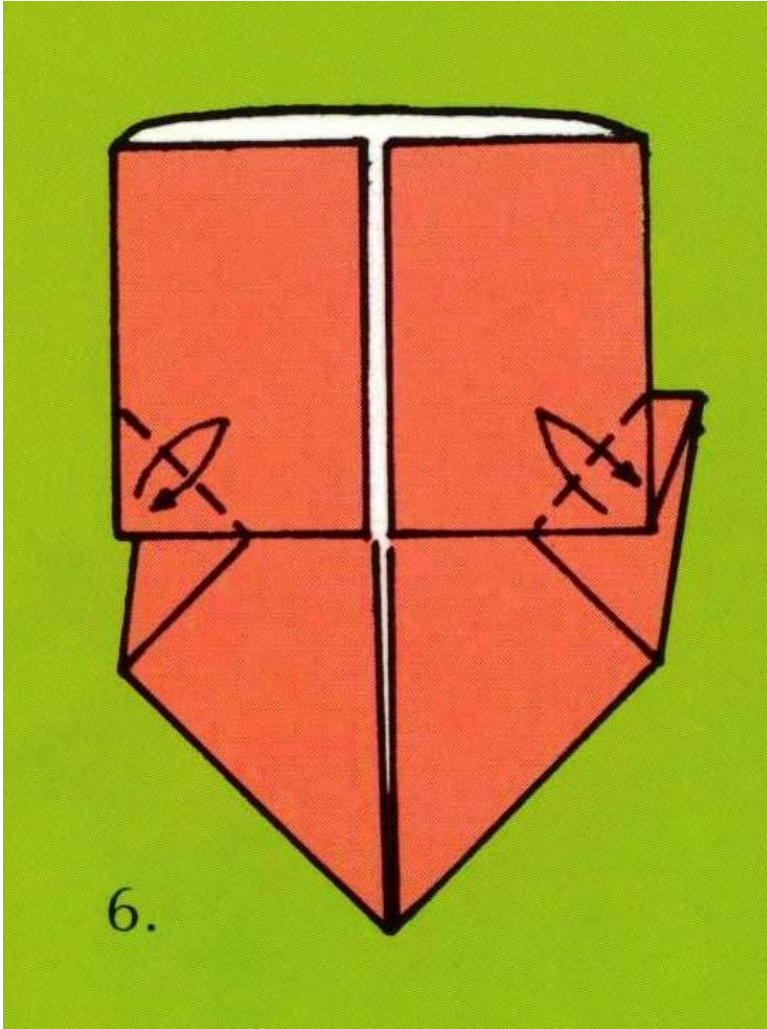

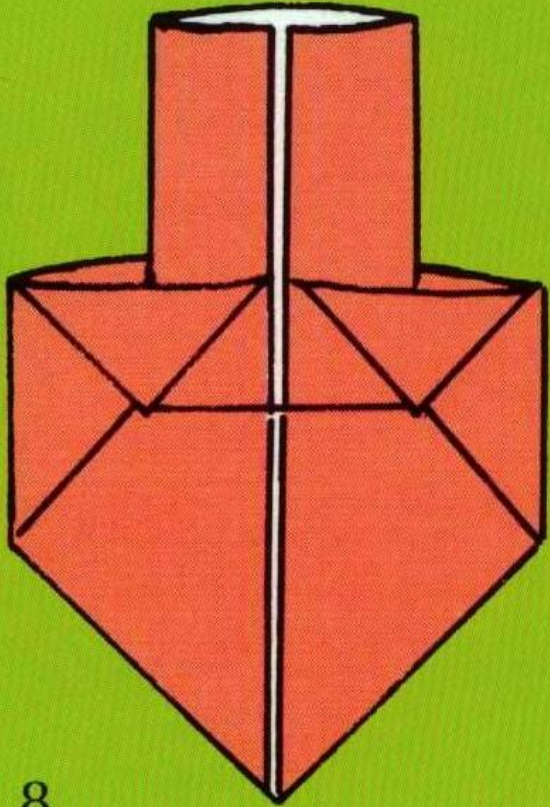

8.

